

AD 2. AERODROMES**SULS AD 2.5-1 AERODROME LOCATION INDICATOR AND NAME**

SULS - MALDONADO/Intl C/C Carlos A. Curbelo "Laguna del Sauce" (Punta del Este)

SULS 2.5-2 AERODROME GEOGRAPHICAL AND ADMINISTRATIVE DATA

1	ARP coordinates and site at AD	☛ 345127S 0550553W Location: geometric centre of the aerodrome
2	Direction and distance from (city)	15 KM WNW from Maldonado/ Punta del Este city
3	Elevation/Reference temperature	29 M (95 FT) / 29°C
4	Geoid undulation at AD ELEV PSN	13 M
5	MAG VAR/Annual change	12° W (JAN 2020) / 0.14° increasing
6	AD operator, address, telephone, telefax, e-mail address, AFS address, website address	Consorcio Aeropuertos Intl S.A. (C.A.I.S.A.) Aeropuerto Intl C/C Carlos A. Curbelo "Laguna del Sauce" Ruta 93 KM 113 Maldonado Tel: 4255 9777 - 4255 9387 - 4255 9388 Telefax: 4255 9389 e-mail: caisa@puntadeleste.aero AFS: SULSYPYX (OPS) website address: www.puntadeleste.aero
7	Types of traffic permitted (IFR/VFR)	IFR/VFR
8	Remarks	☛ Administrative Coordinator: DINACIA

SULS AD 2.5-3 OPERATIONAL HOURS

1	AD Operator	H24
2	Customs and immigration	As AD Operator
3	Health and sanitation	☛ During commercial flights hours; others O/R
4	AIS Briefing Office	Nil
5	ATS Reporting Office (ARO)	As AD Operator
6	MET Briefing Office	As AD Operator
7	ATS	As AD Operator
8	Fuelling	H24
9	Handling	As AD Operator
10	Security	As AD Operator
11	De-icing	Nil
12	Remarks	☛ Nil

SULS AD 2.5-4 HANDLING SERVICES AND FACILITIES

1	<i>Cargo-handling facilities</i>	<ul style="list-style-type: none"> ☛ 4 powered ladders, 2 Ambulift ☛ 2 conveyor belts, 3 GPU 115v 400hz and 2 GPU 28v ☛ 3 ASU 90 and 1 ASU 140 PSI, 10 flats and 4 closed trolleys for suitcases
2	<i>Fuel/oil types</i>	JET A-1 – Fuel 100/130
3	<i>Fuelling facilities/capacity</i>	<ul style="list-style-type: none"> ☛ ANCAP 2 JET A-1 Tanks 100,000 L each ☛ 1 AVGAS Tank 10,000 L ☛ JET A-1 Mobile Unit 20,000 L ☛ AVGAS Mobile Unit 900 L ☛ CAISA JET A-1 Mobile Unit 18,500 L
4	<i>De-icing facilities</i>	Nil
5	<i>Hangar space for visiting aircraft</i>	Nil
6	<i>Repair facilities for visiting aircraft</i>	Nil
7	<i>Remarks</i>	☛ Cargo aircraft Ramp assistance without modification of payload (alternate only)

SULS AD 2.5-5 PASSENGER FACILITIES

1	<i>Hotels</i>	In the city of Punta del Este/Maldonado
2	<i>Restaurants</i>	Service bar, restaurant and confectionery. (Hours of business operation)
3	<i>Transportation</i>	Buses, taxis, remises and cars without driver.
4	<i>Medical facilities</i>	<ul style="list-style-type: none"> ☛ First aid medical company hired by CAISA ☛ Permanent medical presence during commercial flight hours, outside business hours O/R.
5	<i>Bank and Post Office</i>	Foreign Exchange Office at Terminal Area
6	<i>Tourist Office</i>	Intendencia Municipal de Maldonado (Tourist Information)
7	<i>Remarks</i>	Nil

SULS AD 2.5-6 RESCUE AND FIRE FIGHTING SERVICES

1	<i>AD category for fire fighting</i>	CAT 7
2	<i>Rescue equipment</i>	Approach tools and equipment. For events in Laguna del Sauce, motorized boat for rescue and combat, 6 self-inflating life rafts with capacity for 25 people each
3	<i>Capability for removal of disabled aircraft</i>	To coordinate with CAISA aerodrome operator
4	<i>Remarks</i>	Nil

SULS AD 2.5-7 SEASONAL AVAILABILITY - CLEARING

1	<i>Types of clearing equipment</i>	Nil
---	------------------------------------	-----

SULS AD 2.5-8 APRONS, TAXIWAYS AND CHECK LOCATIONS/POSITIONS DATA

1	<i>Apron surface and strength</i>	Surface: asphalt concrete Strength: Commercial Apron: PCN 50/F/C/X/T – 45/R/B/W/T General Aviation Apron: PCN 30/F/B/X/T
2	<i>Taxiway width, surface and strength</i>	Width: "C", "D" 23 M - "E" 10 M - "A" 15 M - "B" 18 M Surface: asphalt concrete Strength: "A" PCN 30/F/B/X/T; "B" 20/F/C/Y/T; "C" 57/F/C/X/T; "D" PCN 43/F/C/X/T; "E" PCN 18/F/C/W/T
3	<i>Altimeter checkpoint location and elevation</i>	THR RWY 01 (345152.57S/0550537.02W) 29 M ✈ THR RWY 08 (345135.59S/0550643.68W) 29 M
4	<i>VOR/INS checkpoints</i>	Nil
5	<i>Remarks</i>	Nil

SULS AD 2.5-9 SURFACE MOVEMENT GUIDANCE AND CONTROL SYSTEM AND MARKINGS

1	Use of aircraft stand ID signs, TWY guide lines and visual docking/parking guidance system of aircraft stands	<ul style="list-style-type: none"> ☛ Apron taxi guidance indications. ☛ Aircraft stands identification signs. ☛ Taxiway centre line and nose aircraft stop bar signs, with aircraft type ID. ☛ Parking guided by Aerodrome Signalman
2	RWY and TWY markings and LGT	<ul style="list-style-type: none"> ☛ RWY 08: <u>Markings</u>: THR, RWY designation, RWY centre line, touchdown zone, aiming point, 180° turn-over for ACFT code letter C, taxiing indicator line from and to TWY, holding point to RWY 01-19. ☛ <u>LGT</u>: THR, RWY edge, RWY end lights and turning edge. ☛ RWY 26: <u>Markings</u>: THR, RWY designation, RWY centre line, touchdown zone, aiming point, 180° turn-over for ACFT code letter C, taxiing indicator line from and to TWY, holding point to RWY 01-19. ☛ <u>LGT</u>: THR, RWY edge, RWY end lights and turning edge. ☛ RWY 01: <u>Markings</u>: THR, RWY designation, RWY centre line, aiming point, taxiing indicator line from and to TWY, holding point to RWY 08-26. <u>LGT</u>: THR, RWY edge, RWY end lights. ☛ RWY 19: <u>Markings</u>: THR, RWY designation, RWY centre line, aiming point, taxiing indicator line from and to TWY, holding point to RWY 08-26. <u>LGT</u>: THR, RWY edge, RWY end lights. ☛ TWY: <u>Markings</u>: TWY centre line, intermediate holding position, RWY holding position, mandatory instructions, directional to parking stands before entering the platform. <u>LGT</u>: TWY edge lights.
3	Stop bars	Nil
4	Remarks	Nil

SULS AD 2.5-10 AERODROME OBSTACLES

In approach/TKOF areas			In circling area and at AD		Remarks	
1			2			3
RWY/Area affected	Obstacle type Elevation Markings/LGT	Coordinates	Obstacle type Elevation Markings/LGT	Coordinates		Nil
a	b	c	a	b		
No data AVBL			No data AVBL			

SULS AD 2.5-11 METEOROLOGICAL INFORMATION PROVIDED

1	<i>Associated MET Office</i>	CAP. CURBELO
2	<i>Hours of service MET Office outside hours</i>	H24 -
3	<i>Office responsible for TAF preparation Periods of validity</i>	Surveillance MET Office CARRASCO H 24
4	<i>Trend forecast Interval of issuance</i>	ATIS (via VOR transmitter continuously)
5	<i>Briefing/consultation provided</i>	Personal inquiries: O/R
6	<i>Flight documentation Language(s) used</i>	Chart, En-Route chart Spanish
7	<i>Charts and other information available for briefing or consultation</i>	S, U, P, T
8	<i>Supplementary equipment available for providing information</i>	ATIS
9	<i>ATS units provided with information</i>	MALDONADO TWR, OPS
10	<i>Additional information (limitation of service, etc.)</i>	Nil

SULS AD 2.5-12 RUNWAY PHYSICAL CHARACTERISTICS

Designations RWY NR	TRUE BRG	Dimensions of RWY (M)	Strength (PCN) and surface of RWY and SWY	THR coordinates.	THR elevation and highest elevation of TDZ of precision APP RWY	
				RWY end coordinates. THR geoid undulation		
1	2	3	4	5	6	
19	177.68°	1 600 x 38	☛43/F/A/X/T Asphalt concrete	345100.79S 0550539.56W 345100.79S 0550539.56W GUND 13.1 M	THR 23 M/75 FT	
01	357.68°	1 600 x 38	☛43/F/A/X/T Asphalt concrete	345152.57S 0550537.02W 345152.57S 0550537.02W GUND 13.1 M	THR 29 M/95 FT	
08	072.42°	2 133 x 45	☛46/F/B/X/T Asphalt concrete	345135.59S 0550643.68W 345135.59S 0550643.68W GUND 13.1 M	☛THR 29 M/95 FT	
26	252.41°	2 133 x 45	☛46/F/B/X/T Asphalt concrete	345114.69S 0550523.69W 345114.69S 0550523.69W GUND 13.1 M	☛THR 22 M/72 FT	
Slope of RWY-SWY	SWY dimensions (M)	CWY dimensions (M)	Strip dimensions (M)	OFZ	RESA (M)	Remarks
7	8	9	10	11	☛12	☛13
-0.19%/0%/+0.4%/ +0.7%/ +0.4%/+0.4 (100 M) (50 M) (480 M) (340 M) (250 M) (380 M)	Nil	Nil	☛1 720 x 280	Nil	☛60 x 60	Nil
-0.4%/-0.4%/-0.7%/ -0.4%/0%/+0.19% (380 M) (250 M) (340 M) (480 M) (50 M) (100 M)	Nil	Nil	☛1 720 x 280	Nil	☛60 x 90	Nil
-0.5%/-0.2%/-0.5%/ (483 M) (1250 M) (400 M)	Nil	Nil	☛2 253 x 280	Nil	☛90 x 90	Open drains, 76 M from RWY axis, on both sides, along the strip.
+0,5%/+0,2%/+0,5%/ (400 M) (1250 M) (483 M)	Nil	Nil	☛2 253 x 280	Nil	☛90 x 90	

SULS AD 2.5-13 DECLARED DISTANCES

<i>RWY Designator</i>	<i>TORA (M)</i>	<i>TODA (M)</i>	<i>ASDA (M)</i>	<i>LDA (M)</i>	<i>Remarks</i>
1	2	3	4	5	6
19	1600	1 600	1 600	1 600	Nil
01	1600	1 600	1 600	1 600	Nil
08	2133	2 133	2 133	2 133	Nil
26	2133	2 133	2 133	2 133	Nil

SULS AD 2.5-14 APPROACH AND RUNWAY LIGHTING

<i>RWY Desig- nator</i>	<i>APCH LGT type LEN INTST</i>	<i>THR LGT colour WBAR</i>	<i>VASIS (MEHT) PAPI</i>	<i>TDZ, LGT LEN</i>	<i>RWY Centre Line LGT Length, spacing, colour, INTST</i>	<i>RWY edge LGT LEN, spacing colour INTST</i>	<i>RWY End LGT colour WBAR</i>	<i>SWY LGT LEN (M) colour</i>	<i>Remarks</i>
1	2	3	4	5	6	7	8	9	10
19	ALS REILS 240 M LIM	Green	PAPI	Nil	Nil	1600 M, 60 M White Amber	Red	Nil	Nil
01	Nil REILS	Green	PAPI	Nil	Nil	1600 M, 60 M White Amber	Red	Nil	Nil
08	MALSR CAT 1 REILS 720 M LIM	Green	PAPI	Nil	Nil	2133 M 60 M White Amber	Red	Nil	Nil
26	ALS REILS 420 M LIM	Green	PAPI	Nil	Nil	2133 M 60 M White Amber	Red	Nil	Nil

SULS AD 2.5-15 OTHER LIGHTING, SECONDARY POWER SUPPLY

1	<i>ABN/IBN location, characteristics and hours of operation</i>	ABN: TWR, GP, FL, W, G. H24
2	<i>LDI location and LGT Anemometer location and LGT</i>	WDI 680 M of ARP lighted / WDI 1188 M of ARP Anemometer: 170 M of RWY centre line
3	<i>TWY edge and centre line lighting</i>	Edge: all the TWY Centre: Nil
4	<i>Secondary power supply/switch-over time</i>	☛ Secondary power supply: 120 KW generator. Switch-over time: 10 SEC; 410 KW generator, switch-over time: 13 SEC and 110 KW generator, switch-over time: 10 SEC
5	<i>Remarks</i>	Nil

SULS AD 2.5-16 HELICOPTER LANDING AREA

1	<i>Coordinates TLOF or THR of FATO</i>	Nil
2	<i>TLOF and/or FATO elevation M/FT</i>	Nil
3	<i>TLOF and FATO area dimensions, surface, strength, marking</i>	
4	<i>True and MAG BRG FATO</i>	Nil
5	<i>Declared distance available</i>	Nil
6	<i>APP and FATO lighting</i>	Nil
7	<i>Remarks</i>	☛ Helicopter PRKG stand on East Apron

SULS AD 2.5-17 ATS AIRSPACE

1	<i>Designation and lateral limits</i>	C. CURBELO CTR CTR arc, radius 10 NM centred at 345129.9S 0550530.2W C. CURBELO ATZ Circle, radius 10 NM centred at 345129.9S 0550530.2W
2	<i>Vertical limits</i>	CTR: SFC up to FL 035 ATZ: SFC up to 750 M
3	<i>Airspace classification</i>	C
4	<i>ATS unit call sign Language(s)</i>	Capitán Curbelo Tower Spanish, english
5	<i>Transition altitude</i>	900 M
6	<i>Remarks</i>	DF on FREQ 118.3, 122.1, 121.5

SULS AD 2.5-18 ATS COMMUNICATION FACILITIES

<i>Service designation</i>	<i>Call sign</i>	<i>Frequency</i>	<i>Hours of operation</i>	<i>Remarks</i>
1	2	3	4	5
TWR	Cap. Curbelo Tower	118.3 MHZ 122.1 MHZ	H24	Nil
G/A/G		122.1 MHZ	H24	Nil

SULS AD 2.5-19 RADIO NAVIGATION AND LANDING AIDS

<i>Type of aid, MAG VAR, Type of supported OP (for VOR/ILS/MLS, give declination)</i>	<i>ID</i>	<i>Frequency</i>	<i>Hours of operation</i>	<i>Position of transmitting antenna coordinates</i>	<i>Elevation of DME transmitting antenna</i>	<i>Remarks</i>
1	2	3	4	5	6	7
VOR/DME	LDS CH 123 X	117.6 MHZ	H24	345129.9S 0550530.2W	030 M/098 FT	Nil

SULS AD 2.5-20 LOCAL TRAFFIC REGULATIONS

1. Procedures for the operations of B787 aircraft

1.1 Limitations

Limited operation to MTOM 169400 KG.
Runway Specifications 08/26: 46/F/B/X/T.
Operation without passengers/cargo.

Landing and Takeoff by RWY 08 or 26

180° turn at the ends head turn area

Exit and entry by TWY D following the instructions of the Platform Management Service

Parking in aircraft stands 2, 3, and extended overnight aircraft stand (W from Commercial platform to E)

Remarks:

- aircraft stand 2 overrides the use of aircraft stands 1,3, 5W and 5E.
- aircraft stand 3 overrides the use of aircraft stands 2,4, 5W and 5E
- special spend-the-night aircraft stand overrides the use of aircraft stand 1.5W and 5E.

SULS AD 2.5-21 NOISE ABATEMENT PROCEDURES

All day and night takeoffs, shall apply the noise abatement procedures, specific to each aircraft.

In the takeoff runway 08, the right turns can not be made before reaching 1500 FT (450 M) of altitude.

SULS AD 2.5-22 FLIGHT PROCEDURES

General

Flights within the SULS CTR shall be made in accordance with instrument flight rules or visual as appropriate.

IFR takeoff minimums

- The minimums applicable for takeoff in terms of ceiling and visibility, for aircraft with two or more engines, shall be the minimums established for the instrument approach procedure published for the runway in use.
- The minimums applicable for takeoff in terms of ceiling, for single-engine aircraft, shall be equal to or higher than that established in the Instrument Approach Charts, and the minimum visibility required shall be 1600 M.

If a visual circulation is necessary, the published minimums will be applied for it.

- a) Aircraft shall be equipped with the instruments necessary for the operation.
- b) The necessary navigation aids must be operational.

Reduction of the IFR takeoff minimums

The minimum visibility required for takeoff with two or more engines will be: 800 M

1) It is required in box 18 of Flight Plan Form an alternate aerodrome post-launch located within the following distances:

- a) twin-engine aircraft: alternated one hour of flight at cruising speed with one engine out of service in ISA atmosphere and windless atmospheric conditions.
- b) three or more aircraft engines: alternated to two hours of flight at cruising speed with all engines running, in ISA atmosphere and windless atmospheric conditions.

Note 1: Indicate the alternate aerodrome post-launch as follows:

RMK / DEP ALTN (4 letters Aerodrome location indicator)

Note 2: Fill in the forms of Repetitive Flight Plan in the box Q "Remarks"

2) MET conditions for the alternate aerodrome post-launch.

The alternate aerodrome post-launch shall at least be operational for IFR landings at the time of takeoff and forecasts indicate that conditions will be at or above minimum values using the aerodrome at the expected time of landing.

3) IFR minimum flight level

The aircraft must be able to climb with one engine inoperative until the IFR flight level appropriate to proceed to the alternate aerodrome post-takeoff or destination aerodrome.

IFR landing minimums

The minimum necessary for landing in terms of ceiling and visibility, shall be the minimum for the instrumental approach procedure published for the runway in use.

NOTE: During peak season (December 15 to March 15) and to reduce the inconvenience caused in certain critical periods of high traffic density, has structured a special air operation planning, especially weekends, holidays and eve of public holidays (Uruguay and Argentina) and in any other period that the circumstances justify its implementation.

- During these periods the air traffic control may assign estimated times of departure for all flights whether VFR or IFR, so prior to the launch Mr. pilots must apply to the Operaciones de aeródromo office (airfield operations office) for the expected delay for output.

The Aerodrome Control permanently kept informed Operations office in terms of delays and estimated times of departure.

- Flights conducted under visual flight rules coming from the adjacent Flight Information Regions, will not be allowed to enter the Montevideo FIR, if previously and according to current regulations have not received their filed flight plan and its subsequent take-off update.

- Flights conducted under visual flight rules that enter Montevideo FIR by Colonia or Isla Martin Garcia (Martin Garcia Island) and directed to the C / C Carlos A. Curbelo INTL Airport must use only the VFR 1 corridor. -

- It is recalled that the lower limit of the corridor is 2,000 FT (600 M), the minimum flight altitude is 2,500 FT (750M) and the maximum FL 075.

- To regulate the operations at times of high traffic density, aircraft directed to SUCA from all airports in the Carrasco TMA will proceed by VFR 1 Corridor, unless expressly authorized by the Air Traffic Control.

- With high traffic density and when weather conditions are not determinants, it will not accept filed flight plans from the air.

- When weather conditions permit, IFR flights may be directed by radar vectoring near the C / C Carlos A. Curbelo INTL Airport, then to proceed for visual transit accordingly.

NOTE: *During this period delays are expected in operations especially on Fridays, Sundays and eve of public holidays from the 16:00 UTC and on Mondays between 10:00 and 16:00 UTC.*

- VFR flights may not cross the final approach areas of the C / C Carlos A. Curbelo INTL Airport without authorization of the respective control.

Minimum vertical separation in the Traffic Circuit of Cap. Curbelo.

Nil.

☛SULS AD 2.5-23 ADDITIONAL INFORMATION

☛Presence of birds at the airport

- ☛Caution is advised in operations due to the presence of birds at the Aerodrome.
- ☛According to the fauna surveys, registered by the Aviary and Fauna Control staff of the Laguna del Sauce International Airport, the overflight of flocks of birds belonging to the Threskiornithidae family stands out, heading W to E over the water mirror of the Laguna del Sauce and the vicinity of the end of RWY 19, during sunrise, returning from E to W during sunset.

☛Resident Birds

- ☛TERO (*Vanellus chilensis*). This species increases its attendance and activity in the reproductive period, during the months of August to January. Make short, low-altitude flights (45 FT). It is active to a lesser extent at night. Weight: 400 grams approximately. Size: approximately 35 CM.
- ☛COTORRA (*Myiopsitta monachus*). Its behavior varies during the different months of the year. They can be seen feeding in green areas or moving towards the hills bordering the airport property. Weight: approximately 100 grams. Size: 30 CM approximately.
- ☛CHIMANGO (*Milvago chimango*). They can be seen alone or in groups, perched on green areas, feeding on insects or perched on posts of the perimeter fence. Weight: 300 grams approximately. Size: 40 CM approximately.
- ☛Given the occurrence of rains, the presence of sea and coastal birds of the Sternidae family, Cook Gull (*Larus dominicanus*) and Brown Hooded Gull (*Chroicocephalus maculipennis*) is verified.
- ☛In the presence of Efimeras (class: insecta, order: ephemeroptera) flocks of Capucho Brown Gull (*Chroicocephalus maculipennis*) are observed feeding on them on the property.

☛Bird and Wildlife Control Program

- ☛Reactive and preventive control methods are used.
- ☛Reactive: it is based on the use of Pyrotechnics.
- ☛Preventive: it is based on inspections of the Maneuvering Area for the identification of hazards and the implementation of Biological Control with falconry. (Flights of trained raptors are carried out, in order to generate fear and expel the fauna that approaches the aerodrome site).

☛Service coverage

- ☛H24 by the Operations Headquarters.

☛Notification of collisions with Fauna

- ☛An IBIS Report track shall be delivered to Operaciones DINACIA Office and another to the Airport Operator's Head of Operations.

SULS AD 2.5-24 CHARTS RELATED TO AN AERODROME

Aerodrome/Heliport Chart - ICAO RWY 01/19.....	AD 2.5-15
Aerodrome/Heliport Chart - ICAO RWY 08/26.....	AD 2.5-17
Aircraft Parking/Docking Chart - ICAO (Commercial Aviation).....	AD 2.5-19
Aircraft Parking/Docking Chart - ICAO (General Aviation).....	AD 2.5-21
Aerodrome Obstacle Chart – OACI Type A – RWY 01/19.....	AD 2.5-23
Aerodrome Obstacle Chart – OACI Type A – RWY 08/26.....	AD 2.5-25
☛ Instrument Approach Chart - ICAO RNP Z RWY 01	AD 2.5-27
☛ Instrument Approach Chart - ICAO RNP Z RWY 08	AD 2.5-29
☛ Instrument Approach Chart - ICAO RNP Z RWY 19	AD 2.5-31
☛ Instrument Approach Chart - ICAO RNP Z RWY 26	AD 2.5-33
☛ Instrument Approach Chart - ICAO VOR Z RWY 01	AD 2.5-35
☛ Instrument Approach Chart - ICAO VOR Z RWY 08	AD 2.5-37
☛ Instrument Approach Chart - ICAO VOR Z RWY 19	AD 2.5-39
☛ Instrument Approach Chart - ICAO VOR Z RWY 26	AD 2.5-41
☛ ATC Surveillance Minimum Altitude Chart - ICAO.....	AD 2.5-43

AERODROME/HELIPORT
CHART - ICAO

34°51'27"S
055°05'53"W
ELEV 29
(95)

TWR 118.3 - 122.1
APRON 118.3 - 122.1

MALDONADO/Intl
C/C Carlos A. Curbelo
Laguna del Sauce

TAXIWAYS:
"A" 15 WIDE; "B" 18 WIDE;
"C" and "D" 23 WIDE;
"E" 10 WIDE

STRIP Rwy 08/26: open drains, 76 M from RWY axis,
on both sides, along the strip.

VAR 12° W - 2020
ANNUAL RATE
OF CHANGE 08" W

ELEVATIONS IN METRES (AND FEET)
DIMENSIONS IN METRES
BEARINGS ARE MAGNETIC

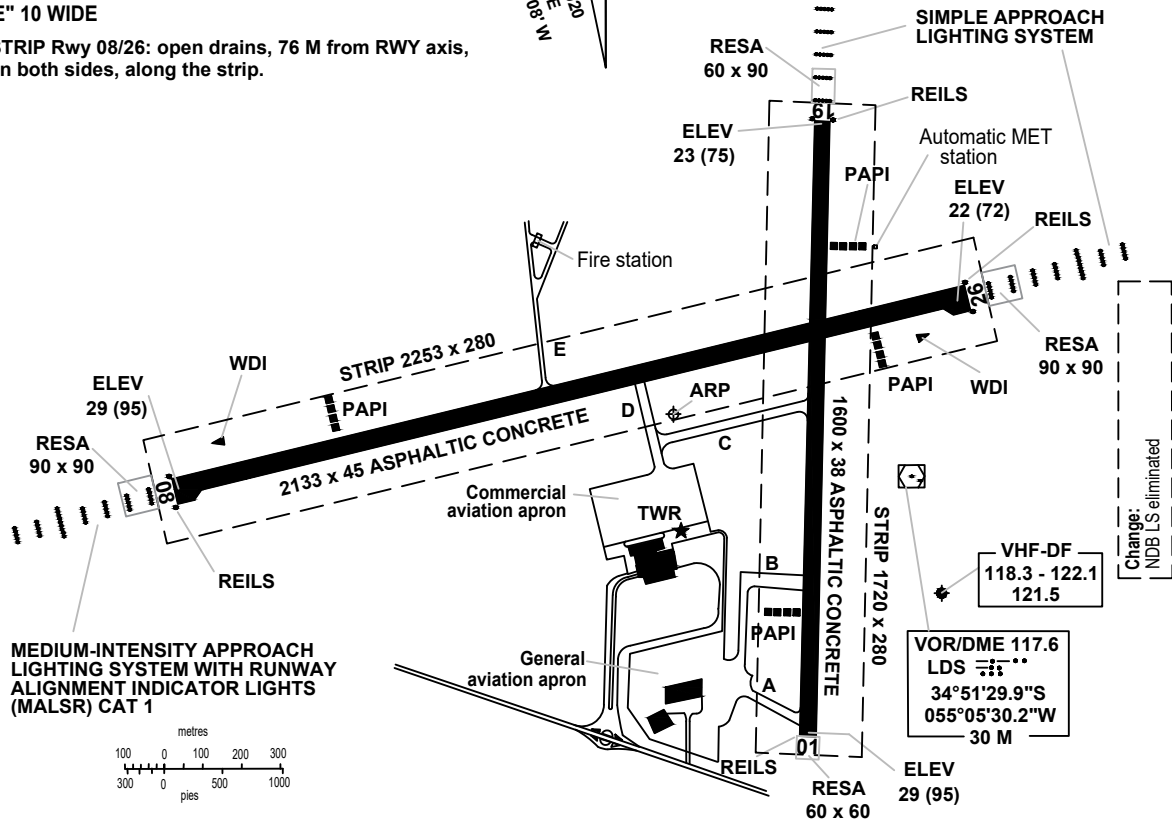

MARKING AIDS RWY 01/19 AND EXIT TWY

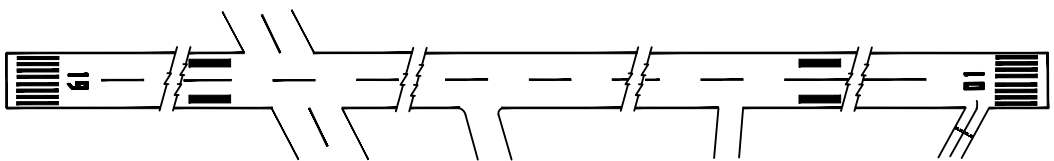

LIGHTING AIDS RWY 01/19 AND EXIT TWY

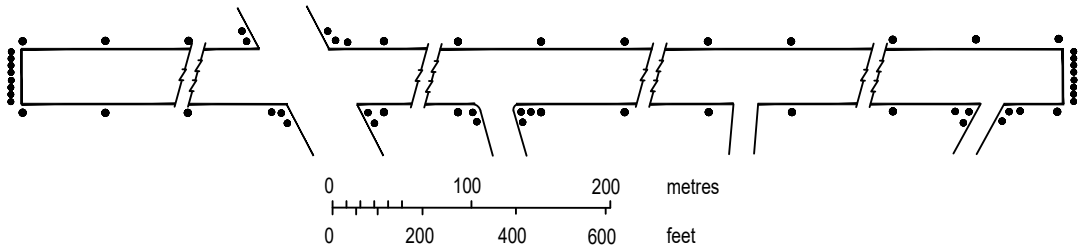

AERODROME/HELIPORT
CHART - ICAO

34°51'27"S
055°05'53"W

ELEV 29
(95)

TWR 118.3 - 122.1
APRON 118.3 - 122.1

MALDONADO/Intl
C/C Carlos A. Curbelo
Laguna del Sauce

RWY	DIRECTION	THR	GUND	BEARING STRENGTH
01	010°	34°51'52.57"S 55°05'37.02"W	13.1 M	Runway
19	190°	34°51'00.79"S 55°05'39.56"W	13.1 M	☛ PCN 43/F/A/X/T
08	084°	34°51'35.59"S 55°06'43.68"W	13.1 M	Runway
26	264°	34°51'14.69"S 55°05'23.69"W	13.1 M	☛ PCN 46/F/B/X/T
Taxiway "A"				☛ PCN 30/F/B/X/T
Taxiway "B"				☛ PCN 20/F/C/Y/T
Taxiway "C"				☛ PCN 57/F/C/X/T
Taxiway "D"				☛ PCN 43/F/C/X/T
Taxiway "E"				☛ PCN 18/F/C/W/T
Commercial apron				☛ PCN 50/F/C/X/T ☛ PCN 45/R/B/W/T
General aviation apron				PCN 30/F/B/X/T

Change:
ARP, PCN

AERODROME/HELIPORT
CHART - ICAO

34°51'27"S
055°05'53"W
ELEV 29
(95)

TWR 118.3 - 122.1
APRON 118.3 - 122.1

MALDONADO/Intl
C/C Carlos A. Curbelo
Laguna del Sauce

TAXIWAYS:
"A" 15 WIDE; "B" 18 WIDE;
"C" and "D" 23 WIDE;
"E" 10 WIDE

STRIP Rwy 08/26: open drains, 76 M from RWY axis,
on both sides, along the strip.

VAR 12° W - 2020
ANNUAL RATE
OF CHANGE 08 W

ELEVATIONS IN METRES (AND FEET)
DIMENSIONS IN METRES
BEARINGS ARE MAGNETIC

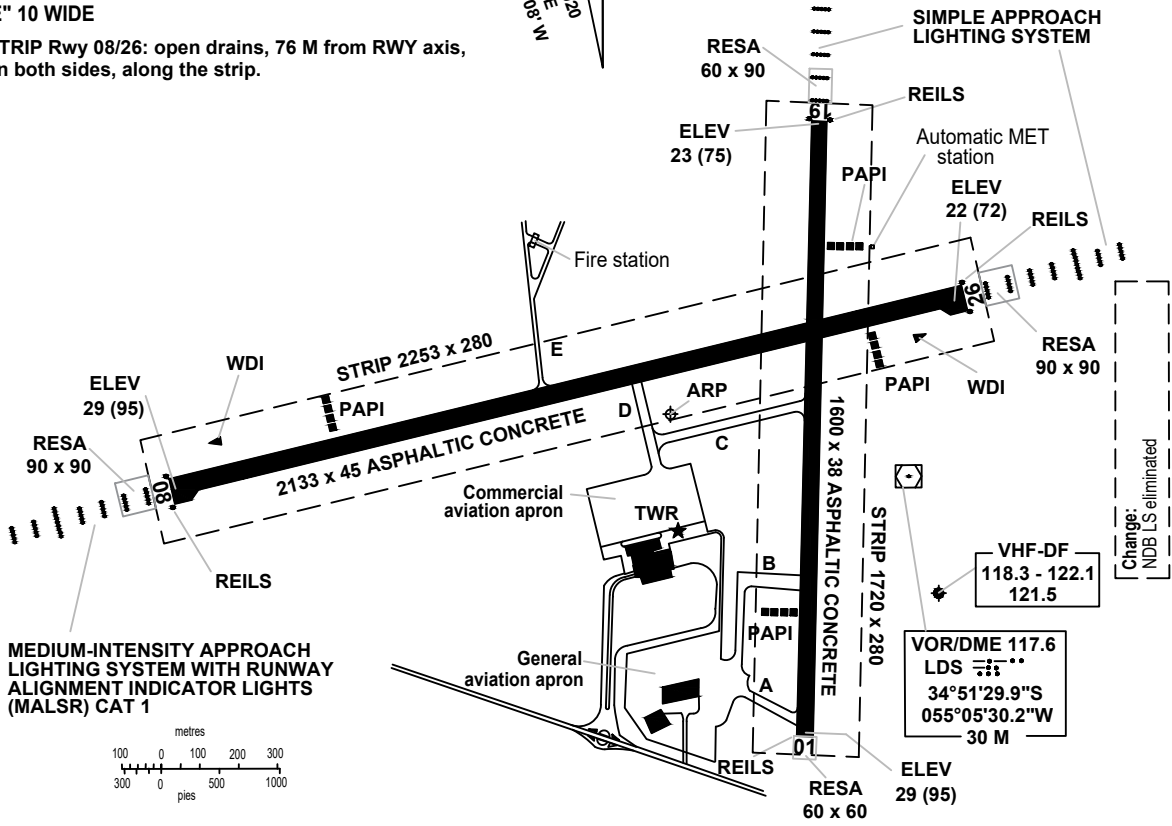

MARKING AIDS RWY 08/26 AND EXIT TWY

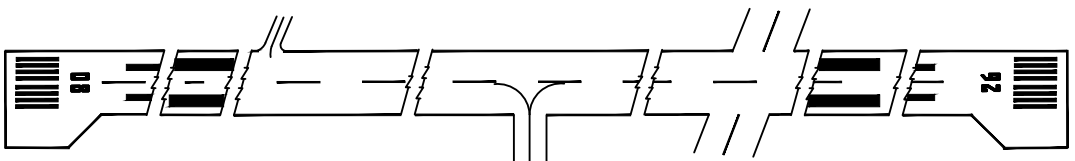

LIGHTING AIDS RWY 08/26 AND EXIT TWY

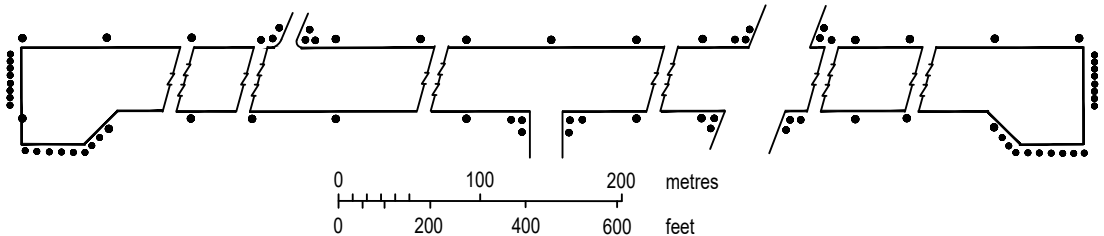

AERODROME/HELIPORT
CHART - ICAO

34°51'27"S
055°05'53"W

ELEV 29
(95)

TWR 118.3 - 122.1
APRON 118.3 - 122.1

MALDONADO/Intl
C/C Carlos A. Curbelo
Laguna del Sauce

RWY	DIRECTION	THR	GUND	BEARING STRENGTH
01	010°	34°51'52.57"S 55°05'37.02"W	13.1 M	Runway
19	190°	34°51'00.79"S 55°05'39.56"W	13.1 M	☛ PCN 43/F/A/X/T
08	084°	34°51'35.59"S 55°06'43.68"W	13.1 M	Runway
26	264°	34°51'14.69"S 55°05'23.69"W	13.1 M	☛ PCN 46/F/B/X/T
Taxiway "A"				☛ PCN 30/F/B/X/T
Taxiway "B"				☛ PCN 20/F/C/Y/T
Taxiway "C"				☛ PCN 57/F/C/X/T
Taxiway "D"				☛ PCN 43/F/C/X/T
Taxiway "E"				☛ PCN 18/F/C/W/T
Commercial apron				☛ PCN 50/F/C/X/T ☛ PCN 45/R/B/W/T
General aviation apron				PCN 30/F/B/X/T

Change:
ARP, PCN

AIRCRAFT PARKING/
DOCKING CHART - ICAO

APRON ELEV
27 (89)

TWR 118.3
APRON 118.3

MALDONADO/Intl
C/C Carlos A. Curbelo
Laguna del Sauce

Commercial Aviation
APRON

ELEVATIONS IN METRES (AND FEET)
DIMENSIONS IN METRES
BEARINGS ARE MAGNETIC



TAXIWAY "D" 23 WIDE

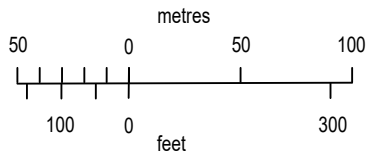
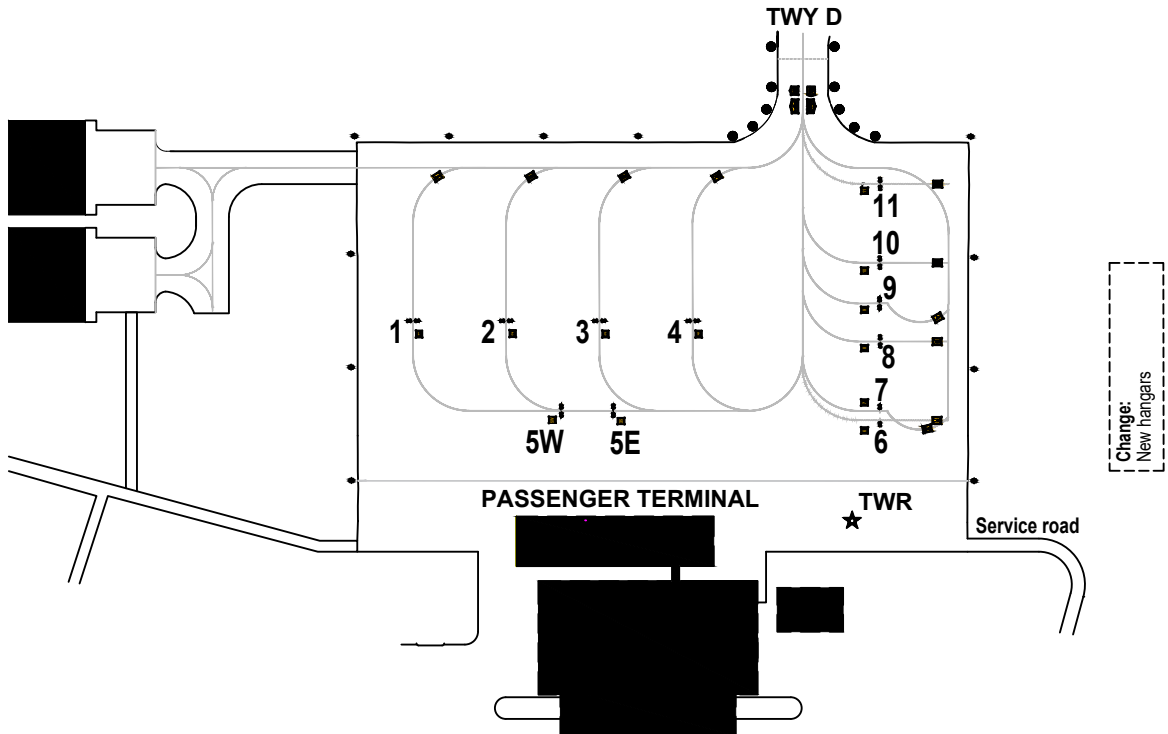

LEGEND	
AIRCRAFT STAND	--
TAXIWAY LIGHT	•

INS COORDINATES FOR AIRCRAFT STANDS					
1	34°51'34.68"S	055°05'59.39"W	6	34°51'33.99"S	055°05'50.85"W
2	34°51'34.26"S	055°05'57.79"W	7	34°51'33.86"S	055°05'50.90"W
3	34°51'33.84"S	055°05'56.19"W	8	34°51'32.88"S	055°05'51.27"W
4	34°51'33.43"S	055°05'54.60"W	9	34°51'32.34"S	055°05'51.49"W
5E	34°51'35.05"S	055°05'55.47"W	10	34°51'31.77"S	055°05'51.71"W
5W	34°51'35.28"S	055°05'56.36"W	11	34°51'30.65"S	055°05'52.13"W

TAXIWAY AND APRON STRENGT
TAXIWAY "D": PCN 43/F/C/X/T
APRON: PCN 50/F/C/X/T - 45/R/BW/T

**INTENTIONALLY
LEFT BLANK**

AIRCRAFT PARKING/
DOCKING CHART - ICAO

APRON ELEV
28 (92)

TWR 118.3
APRON 118.3

MALDONADO/Intl
C/C Carlos A. Curbelo
Laguna del Sauce

ELEVATIONS IN METRES (AND FEET)
DIMENSIONS IN METRES
BEARINGS ARE MAGNETIC

General Aviation
APRON

VAR 12° W - 2020
ANNUAL RATE
OF CHANGE 08" W

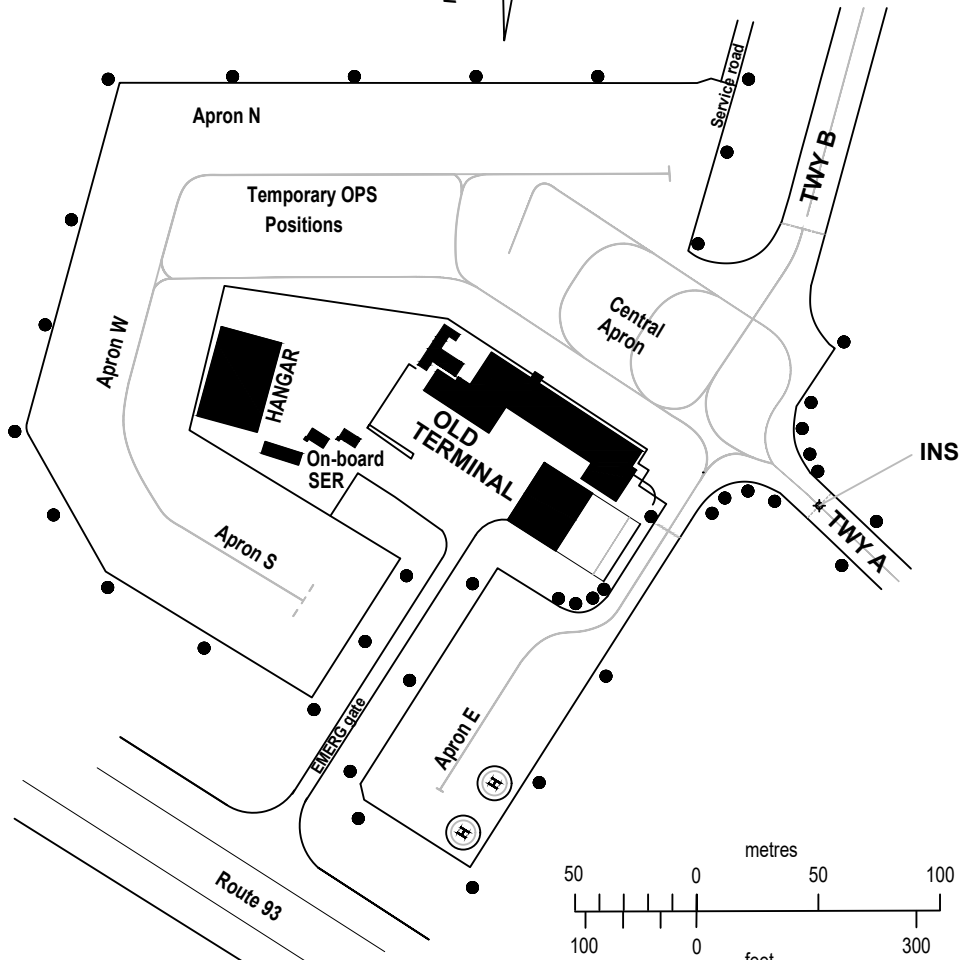

Change:
New Hangars

LEGEND	
AIRCRAFT STAND	--
TAXIWAY LIGHT	•
INS COORDINATES FOR AIRCRAFT STANDS	
34°51'49.46"S 055°05'42.70"W	

TAXIWAY "A" 15 WIDE
TAXIWAY "B" 18 WIDE

BEARING STRENGTH TAXIWAY "A" PCN 30/F/C/W/T
BEARING STRENGTH TAXIWAY "B" PCN 18/F/C/W/T
BEARING STRENGTH APRONS N, S, W PCN 30/F/C/W/T
BEARING STRENGTH APRON E PCN 18/F/C/W/T

APRON N, S, E, W ONLY ACFT CODE LETTER A and B LIMITED UP TO 20 M OF WINGSPAN
TEMPORARY OPS POSITIONS ACFT CODE LETTER A and B LIMITED UP TO 18 M OF WINGSPAN
CENTRAL APRON ONLY ACFT CODE LETTER C

**INTENTIONALLY
LEFT BLANK**

AERODROME OBSTACLE CHART - ICAO

TYPE A (OPERATING LIMITATIONS)

DIMENSIONS AND ELEVATIONS IN METRES

MALDONADO/Intl C/C Carlos A. Curbelo - Laguna del Sauce

MAGNETIC VARIATION 12° W JAN 2020

RWY 01 / 19

DECLARED DISTANCES			
RWY 01		RWY 19	
1600	TAKE-OFF RUN AVAILABLE	1600	
1600	TAKE-OFF DISTANCE AVAILABLE	1600	
1600	ACCELERATE STOP DISTANCE AVAILABLE	1600	
1600	LANDING DISTANCE AVAILABLE	1600	

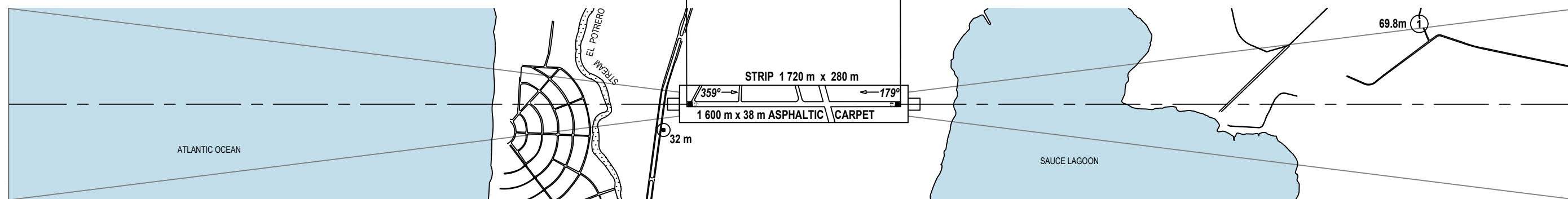
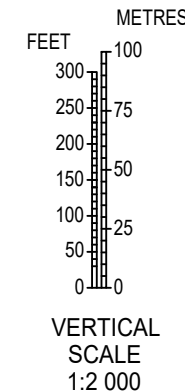
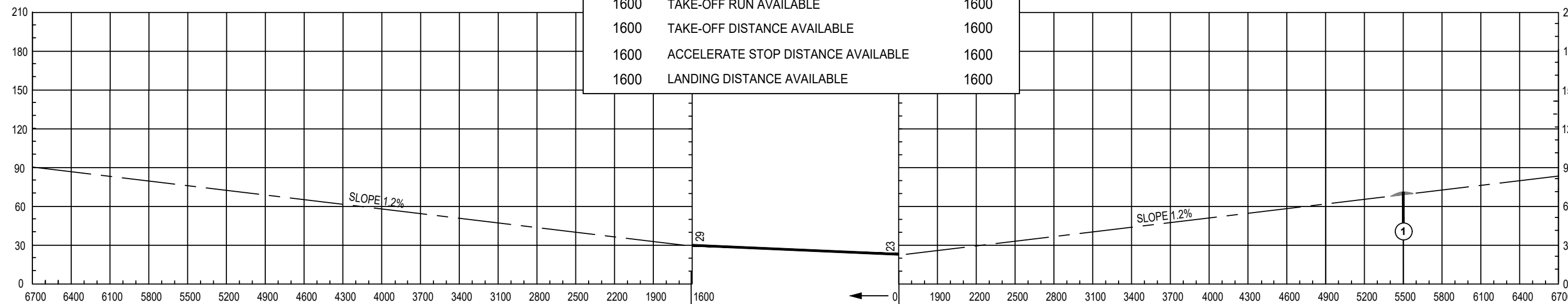

LEGEND	
IDENTIFICATION NUMBER	①
TREE OR SHRUB	✱
HIGHWAY	====
POLE, TOWER, SPIRE, ANTENNA, ETC.	⊙
BUILDING OR LARGE STRUCTURE	■
RAILROAD	—+—+—+—
TERRAIN CONTOUR	~
TERRAIN PENETRATING OBSTACLE PLANE	▒

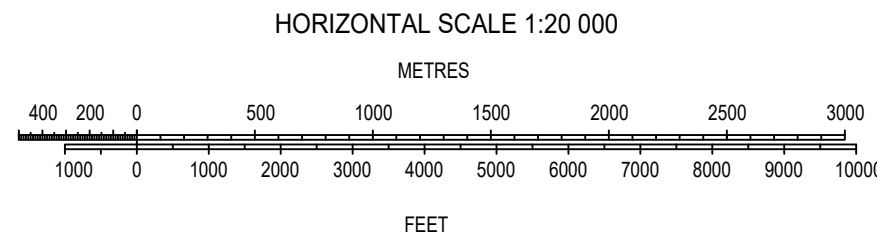

ORDER OF ACCURACY
HORIZONTAL 00 M
VERTICAL 00 M

Change: Horizontal scale

**INTENTIONALLY
LEFT BLANK**

AERODROME OBSTACLE CHART - ICAO

TYPE A (OPERATING LIMITATIONS)

DIMENSIONS AND ELEVATIONS IN METRES

MALDONADO/Intl C/C Carlos A. Curbelo - Laguna del Sauce

MAGNETIC VARIATION 12° W JAN 2020

RWY 08 / 26

DECLARED DISTANCES

RWY 08	RWY 26
2133 TAKE-OFF RUN AVAILABLE	2133
2133 TAKE-OFF DISTANCE AVAILABLE	2133
2133 ACCELERATE STOP DISTANCE AVAILABLE	2133
2133 LANDING DISTANCE AVAILABLE	2133

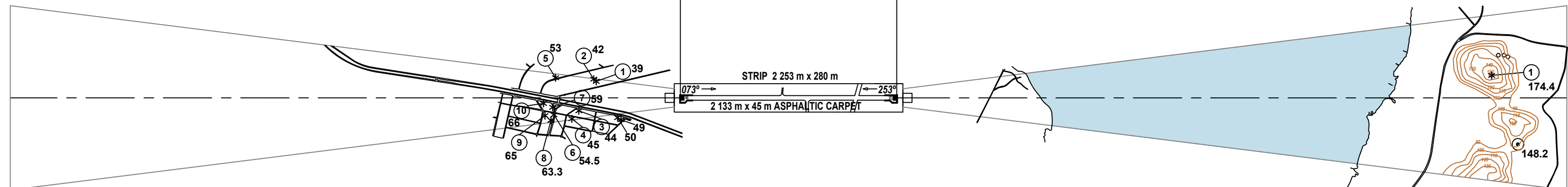
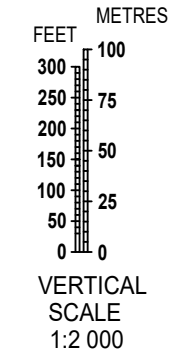
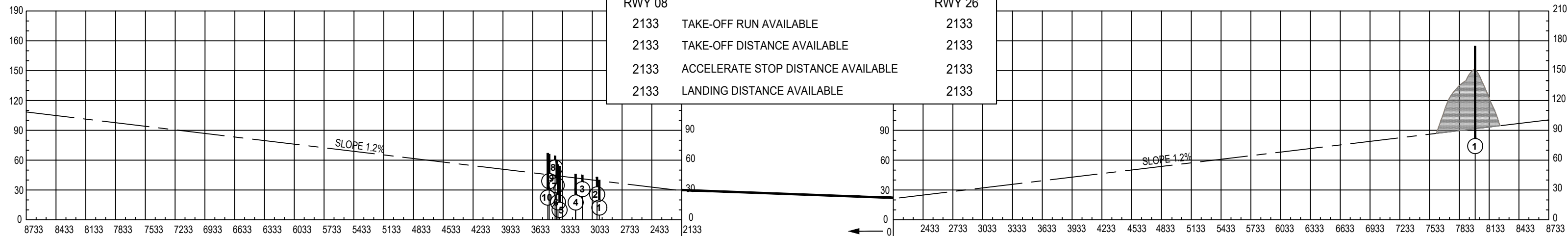

LEGEND	
IDENTIFICATION NUMBER	①
TREE OR SHRUB	✳
HIGHWAY	====
POLE, TOWER, SPIRE, ANTENNA, ETC.	⊙
BUILDING OR LARGE STRUCTURE	■
RAILROAD	+ + + +
TERRAIN CONTOUR	~ ~ ~
TERRAIN PENETRATING OBSTACLE PLANE	▲

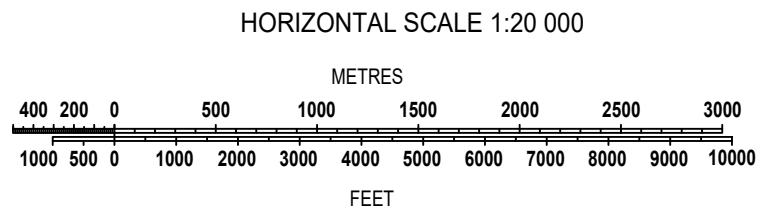

ORDER OF ACCURACY
HORIZONTAL 00 M
VERTICAL 00 M

Change:
Horizontal scale

**INTENTIONALLY
LEFT BLANK**

INSTRUMENT
APPROACH
CHART - ICAO

AERODROME ELEV **95 FT**
HEIGHTS RELATED TO
THR RWY 01 - ELEV 95 FT

TWR 118.3 - 122.1
ATIS 117.6

MALDONADO/Intl
C/C Carlos A. Curbelo
Laguna del Sauce
RNP Z RWY 01

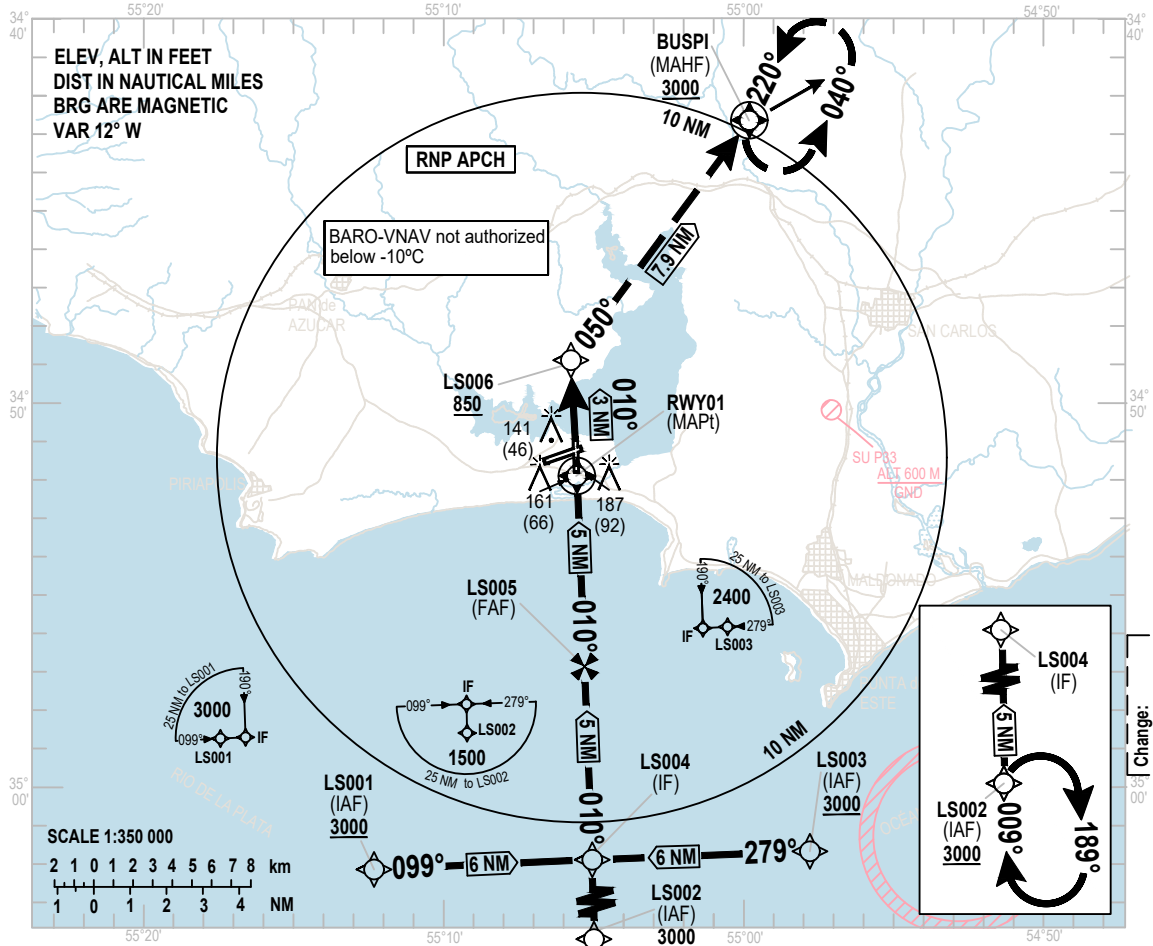

NM to next WPT	RWY01	5	4	3	2	0.9	0.6
ALTITUDE		1740	1419	1100	782	440	345
HEIGHT		1645	1324	1005	687	345	250

MISSED
APPROACH
Climb up to 3000 FT:
heading 010° up to LS006,
cross with 850 FT or superior,
then heading 050°
to hold in BUSPI.

NOTE:
3.5% MNM of missed
approach gradient,
established by airspace.

RDH 50
TRANSITION ALT 3000

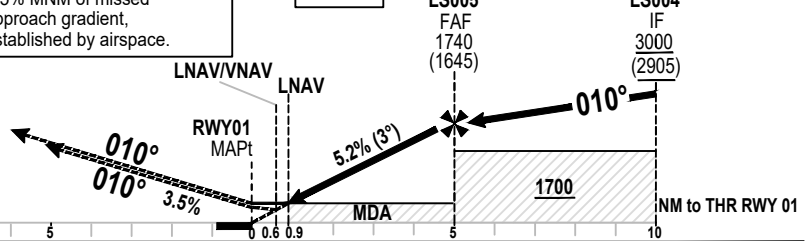

OCA / OCH	A	B	C	D
LNAV/VNAV		345(250)		
VIS		1300 M		
LNAV		440(345)		
VIS		1600 M		

Ground Speed	KT	80	100	120	140	160	180
FAF - MAPt	Feet/Min	450	550	650	750	850	950
Vertical speed of descent 5.2%							

INSTRUMENT
APPROACH
CHART - ICAO

AERODROME ELEV **95 FT**
HEIGHTS RELATED TO
THR RWY 01 - ELEV 95 FT

TWR 118.3 - 122.1
ATIS 117.6

MALDONADO/Intl
C/C Carlos A. Curbelo
Laguna del Sauce
RNP W RWY 01

TABULAR DESCRIPTION

RNP Z RWY 01											
Serial Number	Path Descriptor	Waypoint Identifier	Fly-Over	Course °M(°T)	Magnetic Variation	Distance (NM)	Turn Direction	Altitude (FT)	Speed Limit (Knots/h)	VPA/TCH	Navigation Specification
010	IF	LS001	-	-	-	-	-	+3000	-	-	RNP APCH
020	TF	LS004	-	099(087.7)	-	6	-	+3000	-	-	RNP APCH
010	IF	LS002	-	-	-	-	-	+3000	-	-	RNP APCH
020	TF	LS004	-	009(357.7)	-	5	-	+3000	-	-	RNP APCH
010	IF	LS003	-	-	-	-	-	+3000	-	-	RNP APCH
020	TF	LS004	-	279(267.7)	-	6	-	+3000	-	-	RNP APCH
010	IF	LS004	-	-	-	-	-	+3000	-	-	RNP APCH
020	TF	LS005	-	010(357.7)	-	5	-	+1740	-	-3°	RNP APCH
030	TF	RWY01	Yes	010(357.7)	-	5	-	@145	-	-3°/50FT	RNP APCH
040	TF	LS006	-	010(357.7)	-	3	-	+850	-	-	RNP APCH
050	TF	BUSPI	Yes	050(038.5)	-	7.9	R	+3000	-	-	RNP APCH
060	HM	BUSPI	Yes	220(208.0)	-	-	L	+3000	-	-	RNP APCH

Change:
New chart

WAYPOINT LIST

RNP Z RWY 01	
Waypoint Identifier	Coordinates
LS001	35°02'07.43"S 055°12'25.54"W
LS002	35°06'53.29"S 055°04'52.69"W
LS003	35°01'38.24"S 054°57'49.50"W
LS004	35°01'53.05"S 055°05'07.50"W
LS005	34°56'52.81"S 055°05'22.27"W
RWY01	34°51'52.57"S 055°05'37.02"W
LS006	34°48'52.40"S 055°05'45.90"W
BUSPI	34°42'39.70"S 054°59'47.20"W

INSTRUMENT
APPROACH
CHART - ICAO

AERODROME ELEV **95 FT**
HEIGHTS RELATED TO
THR RWY 08 - ELEV 95 FT

TWR 118.3 - 122.1
ATIS 117.6

MALDONADO/Int'l
C/C Carlos A. Curbelo
Laguna del Sauce

RNP Z RWY 08

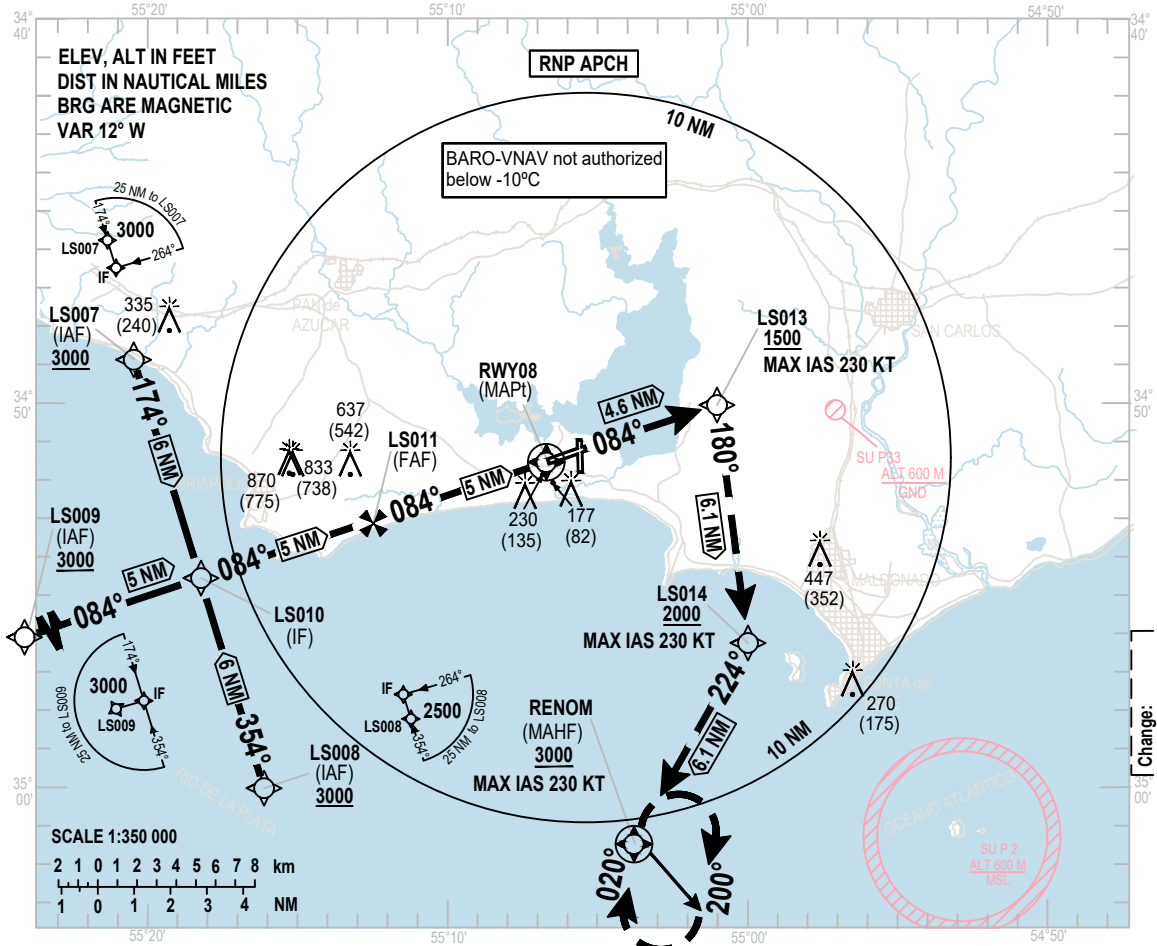

NM to next WPT	RWY08	5	4	3	2	1.1	0.7
ALTITUDE		1740	1416	1103	779	480	380
HEIGHT		1645	1321	1008	684	385	285

TRANSITION ALT **3000**

RDH **50**

NOTE:
5% MNM of missed approach gradient up to 1500 FT, established by airspace.

MISSED APPROACH
Climb up to 3000 FT keep heading 084° to LS013, 1500 FT or above, then heading 180° to LS014, 2000 FT or above then heading 224° to RENOM for hold.
MAX IAS 230 KT.
NM to THR RWY 08

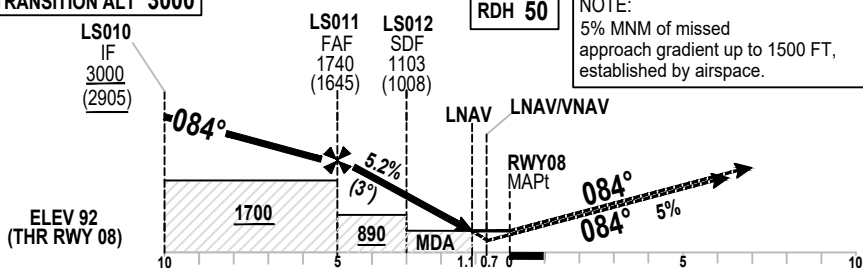

OCA / OCH	A	B	C	D
LNAV/VNAV		380(285)		
VIS		900 M - 1400 M	ALS INOP	
LNAV		480(385)		
VIS		1400 M - 1800 M	ALS INOP	

Ground Speed	KT	80	100	120	140	160	180
FAF - MAPt	Feet/Min	450	550	650	750	850	1000
Vertical speed of descent							

INSTRUMENT
APPROACH
CHART - ICAO

AERODROME ELEV **95 FT**
HEIGHTS RELATED TO
THR RWY 08 - ELEV 95 FT

TWR 118.3 - 122.1
ATIS 117.6

MALDONADO/Intl
C/C Carlos A. Curbelo
Laguna del Sauce

RNP Z RWY 08

TABULAR DESCRIPTION

RNP Z RWY 08											
Serial Number	Path Descriptor	Waypoint Identifier	Fly-Over	Course °M(°T)	Magnetic Variation	Distance (NM)	Turn Direction	Altitude (FT)	Speed Limit (Knots/h)	VPA/TCH	Navigation Specification
010	IF	LS007	-	-	-	-	-	+3000	-	-	RNP APCH
020	TF	LS010	-	174(162.5)	-	6	-	+3000	-	-	RNP APCH
010	IF	LS008	-	-	-	-	-	+3000	-	-	RNP APCH
020	TF	LS010	-	354(342.5)	-	6	-	+3000	-	-	RNP APCH
010	IF	LS009	-	-	-	-	-	+3000	-	-	RNP APCH
020	TF	LS010	-	084(072.5)	-	5	-	+3000	-	-	RNP APCH
010	IF	LS010	-	-	-	-	-	+3000	-	-	RNP APCH
020	TF	LS011	-	084(072.5)	-	5	-	+1740	-	-3°	RNP APCH
030	TF	LS012	-	084(072.5)	-	2	-	+1103	-	-3°	RNP APCH
040	TF	RWY08	Yes	084(072.5)	-	3	-	@142	-	-3°/50FT	RNP APCH
050	TF	LS013	-	084(072.2)	-	4.6	-	+1500	IAS 230	-	RNP APCH
060	TF	LS014	-	180(168.5)	-	6.1	R	+2000	IAS 230	-	RNP APCH
070	TF	RENOM	Yes	224(212.5)	-	6.1	R	+3000	IAS 230	-	RNP APCH
080	HM	RENOM	Yes	020(008.5)	-	-	R	+3000	IAS 230	-	RNP APCH

Change:
New chart

WAYPOINT LIST

RNP Z RWY 08	
Waypoint Identifier	Coordinates
LS007	34°48'52.59"S 055°20'30.41"W
LS008	35°00'20.50"S 055°16'07.59"W
LS009	34°56'06.64"S 055°24'07.21"W
LS010	34°54'36.57"S 055°18'19.15"W
LS011	34°53'06.22"S 055°12'31.31"W
LS012	34°52'30.00"S 055°10'12.23"W
RWY08	34°51'35.59"S 055°06'43.68"W
LS013	34°50'12.22"S 055°01'24.14"W
LS014	34°56'14.95"S 054°59'50.79"W
RENOM	35°01'25.02"S 055°03'48.53"W

INSTRUMENT
APPROACH
CHART - ICAO

AERODROME ELEV **95 FT**
HEIGHTS RELATED TO
THR RWY 19 - ELEV 75 FT

TWR 118.3 - 122.1
ATIS 117.6

MALDONADO/Intl
C/C Carlos A. Curbelo
Laguna del Sauce
RNP Z RWY 19

TABULAR DESCRIPTION

RNP Z RWY 19											
Serial Number	Path Descriptor	Waypoint Identifier	Fly-Over	Course °M(°T)	Magnetic Variation	Distance (NM)	Turn Direction	Altitude (FT)	Speed Limit (Knots/h)	VPA/TCH	Navigation Specification
010	IF	LS015	-	-	-	-	-	+3000	-	-	RNP APCH
020	TF	LS018	-	100(087.7)	-	5	-	+3000	-	-	RNP APCH
010	IF	LS016	-	-	-	-	-	+3000	-	-	RNP APCH
020	TF	LS018	-	280(267.7)	-	6	-	+3000	-	-	RNP APCH
010	IF	LS017	-	-	-	-	-	+3000	-	-	RNP APCH
020	TF	LS018	-	190(177.7)	-	5	-	+3000	-	-	RNP APCH
010	IF	LS018	-	-	-	-	-	+3000	-	-	RNP APCH
020	TF	LS019	-	190(177.7)	-	5	-	+1720	-	-3°	RNP APCH
030	TF	LS020	-	190(177.7)	-	3.2	-	+700	-	-3°	RNP APCH
040	TF	RWY19	Yes	190(177.7)	-	1.8	-	@125	-	-3°/50FT	RNP APCH
050	TF	RENOM	Yes	184(171.7)	-	10.5	-	+3000	IAS 230	-	RNP APCH
060	HM	RENOM	Yes	003(351.2)	-	-	R	+3000	IAS 230	-	RNP APCH

Change:
New chart

WAYPOINT LIST

RNP Z RWY 19	
Waypoint Identifier	Coordinates
LS015	34°41'12.25"S 055°12'12.45"W
LS016	34°40'45.53"S 054°58'52.80"W
LS017	34°36'00.03"S 055°06'23.60"W
LS018	34°41'00.29"S 055°06'08.95"W
LS019	34°46'00.54"S 055°05'54.27"W
LS020	34°49'12.70"S 055°05'44.75"W
RWY19	34°51'00.79"S 055°05'39.56"W
RENOM	35°01'25.02"S 055°03'48.53"W

INSTRUMENT
APPROACH
CHART - ICAO

AERODROME ELEV **95 FT**
HEIGHTS RELATED TO
THR RWY 26 - ELEV 72 FT

TWR 118.3 - 122.1
ATIS 117.6

MALDONADO/Intl
C/C Carlos A. Curbelo
Laguna del Sauce
RNP Z RWY 26

TABULAR DESCRIPTION

RNP Z RWY 26											
Serial Number	Path Descriptor	Waypoint Identifier	Fly-Over	Course °M(°T)	Magnetic Variation	Distance (NM)	Turn Direction	Altitude (FT)	Speed Limit (Knots/h)	VPA/TCH	Navigation Specification
010	IF	LS021	-	-	-	-	-	+3000	-	-	RNP APCH
020	TF	LS024	-	264(252.3)	-	5	-	+3000	-	-	RNP APCH
010	IF	LS022	-	-	-	-	-	+3000	-	-	RNP APCH
020	TF	LS024	-	174(162.3)	-	6	-	+3000	-	-	RNP APCH
010	IF	LS023	-	-	-	-	-	+3000	-	-	RNP APCH
020	TF	LS024	-	354(342.3)	-	6	-	+3000	-	-	RNP APCH
010	IF	LS024	-	-	-	-	-	+3000	-	-	RNP APCH
020	TF	LS025	-	264(252.4)	-	5	-	+1720	-	-3°	RNP APCH
030	TF	LS026	-	264(252.4)	-	2.5	-	+915	-	-3°	RNP APCH
040	TF	RWY26	Yes	264(252.4)	-	2.5	-	@119	-	-3°/50FT	RNP APCH
050	TF	LS027	-	264(252.4)	-	3.5	-	+1200	-	-	RNP APCH
060	TF	RENOM	Yes	165(153.0)	-	10.2	L	+3000	-	-	RNP APCH
070	HM	RENOM	Yes	020(008.4)	-	-	R	+3000	-	-	RNP APCH

Change:
New chart

WAYPOINT LIST

RNP Z RWY 26	
Waypoint Identifier	Coordinates
LS021	34°46'40.97"S 054°48'02.22"W
LS022	34°42'28.94"S 054°56'01.95"W
LS023	34°53'55.98"S 054°51'36.07"W
LS024	34°48'12.48"S 054°53'49.16"W
LS025	34°49'43.72"S 054°59'36.32"W
LS026	34°50'29.24"S 055°02'29.98"W
RWY26	34°51'14.69"S 055°05'23.69"W
LS027	34°52'18.08"S 055°09'26.46"W
RENOM	35°01'25.02"S 055°03'48.53"W

INSTRUMENT
APPROACH
CHART - ICAO

AERODROME ELEV **95 FT**
HEIGHTS RELATED TO
THR RWY 01 - ELEV 95 FT

TWR 118.3 - 122.1
ATIS 117.6

MALDONADO/Intl
C/C Carlos A. Curbelo
Laguna del Sauce
VOR Z RWY 01

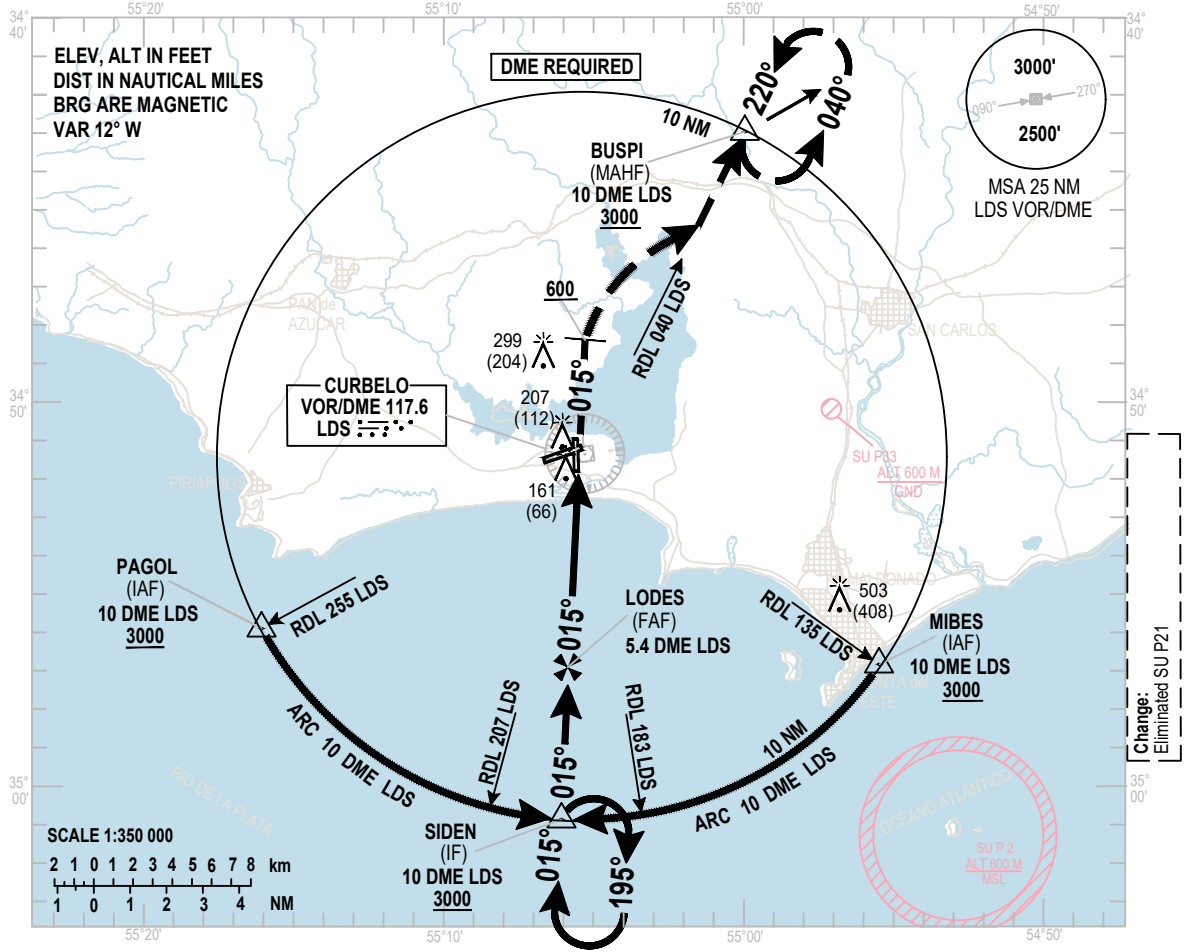

TRANSITION ALT 3000

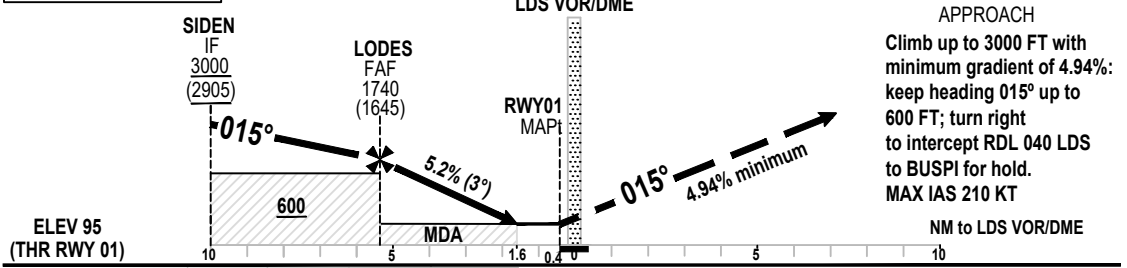

OCA/H		A	B	C	D	KT									
Straight-in Approach	VOR/DME VIS	460(365)				80	100	120	140	160	180	200			
	Vertical speed of descent 5.2%	1700 M				Feet/Min	450	550	650	750	850	950			
	NM to LDS VOR	5.4	4	3	2	1.6									
Altitude Height		1740	1419	1100	782	460									
		1645	1324	1005	687	365									

INSTRUMENT
APPROACH
CHART - ICAO

AERODROME ELEV **95 FT**
HEIGHTS RELATED TO
THR RWY 01 - ELEV 95 FT

TWR 118.3 - 122.1
ATIS 117.6

MALDONADO/Int'l
C/C Carlos A. Curbelo
Laguna del Sauce
VOR Z RWY 01

AERONAUTICAL DATA TABULATION

VOR Z approach to RWY 01 from MIBES or PAGOL	
Fix / Point	Coordinates
MIBES (IAF)	34°56'57.84"S 054°55'18.89"W
PAGOL (IAF)	34°56'01.14"S 055°16'21.11"W
SIDEN (IF)	35°01'29.95"S 055°06'10.76"W
LODES (FAF)	34°56'52.63"S 055°05'51.99"W
LDS VOR/DME	34°51'29.9"S 055°05'30.2"W
BUSPI (MAHF)	34°42'39.70"S 054°59'47.20"W
LS028 (FTP) (MAPT)	34°51'52.60"S 055°05'31.73"W
RWY01	34°51'52.57"S 055°05'37.02"W

Change:
New chart

INSTRUMENT
APPROACH
CHART - ICAO

AERODROME ELEV **95 FT**
HEIGHTS RELATED TO
THR RWY 08 - ELEV 95 FT

TWR 118.3 - 122.1
ATIS 117.6

MALDONADO/Intl
C/C Carlos A. Curbelo
Laguna del Sauce

VOR Z RWY 08

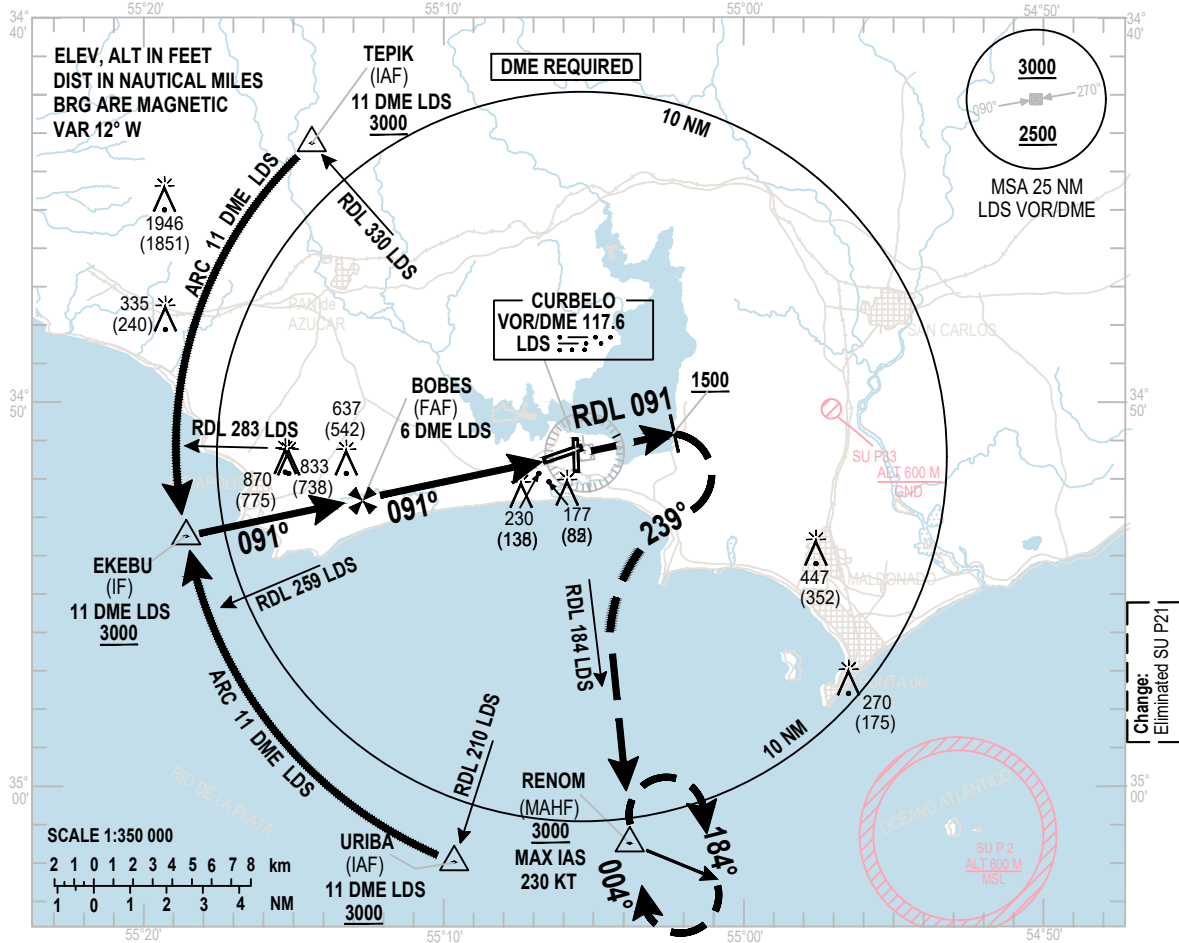

TRANSITION ALT 3000

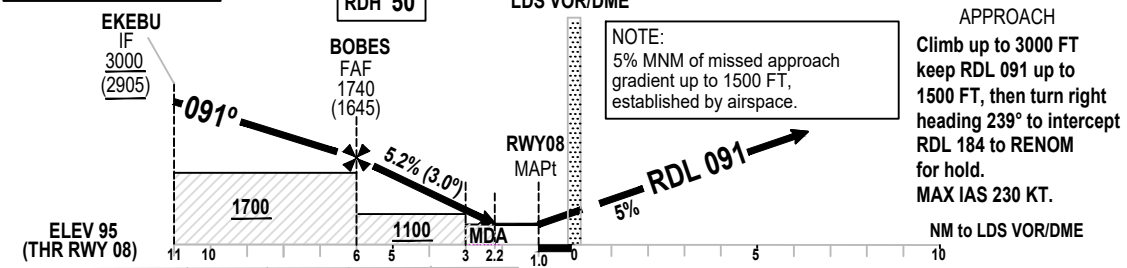

Straight-in Approach	OCA/H	A	B	C	D
	VOR/DME	530(435)			
	VIS	1600 M - 2000 M ALS INOP			

Vertical speed of descent 5.2%	Feet/Min	450	550	650	750	850	1000
	NM to LDS DME	6	5	4	3	2.2	
Altitude Height		1740	1415	1097	779	530	
		1645	1320	1002	684	435	

INSTRUMENT
APPROACH
CHART - ICAO

AERODROME ELEV **95 FT**
HEIGHTS RELATED TO
THR RWY 08 - ELEV 95 FT

TWR 118.3 - 122.1
ATIS 117.6

MALDONADO/Int'l
C/C Carlos A. Curbelo
Laguna del Sauce
VOR Z RWY 08

AERONAUTICAL DATA TABULATION

VOR Z approach to RWY 08 from TEPIK or URIBA	
Fix / Point	Coordinates
TEPIK (IAF)	34°43'17.26"S 055°14'24.83"W
URIBA (IAF)	35°01'58.26"S 055°09'40.21"W
EKEBU (IF)	34°53'30.75"S 055°18'39.03"W
BOBES (FAF)	34°52'36.01"S 055°12'40.47"W
LS029 (FTP) (MAPT)	34°51'40.97"S 055°06'42.04"W
RWY08	34°51'35.59"S 055°06'43.68"W
LDS VOR/DME	34°51'29.9"S 055°05'30.2"W
RENOM (MAHF)	35°01'25.02"S 055°03'48.53"W

Change:
New chart

INSTRUMENT
APPROACH
CHART - ICAO

AERODROME ELEV **95 FT**
HEIGHTS RELATED TO
THR RWY 19 - ELEV 75 FT

TWR 118.3 - 122.1
ATIS 117.6

MALDONADO/Intl
C/C Carlos A. Curbelo
Laguna del Sauce
VOR Z RWY 19

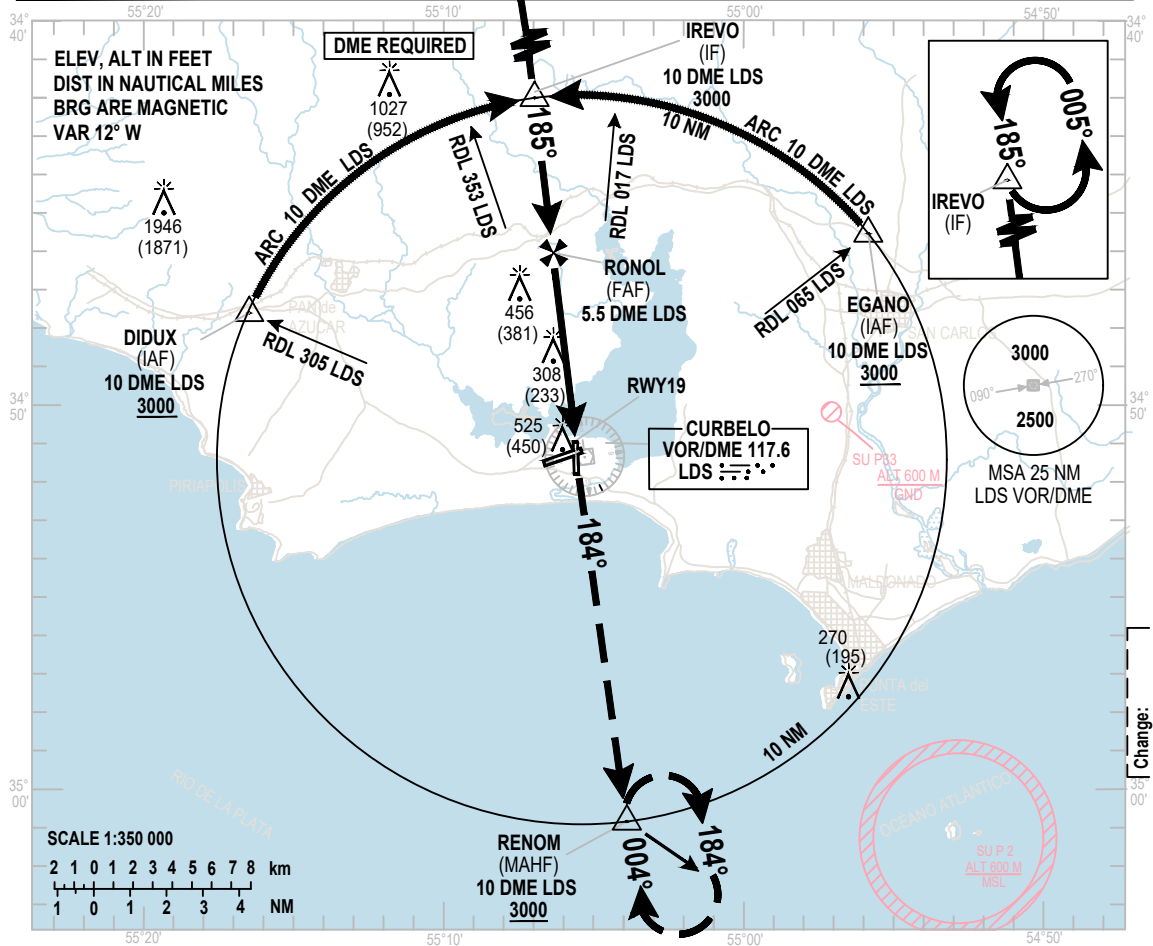

TRANSITION ALT 3000

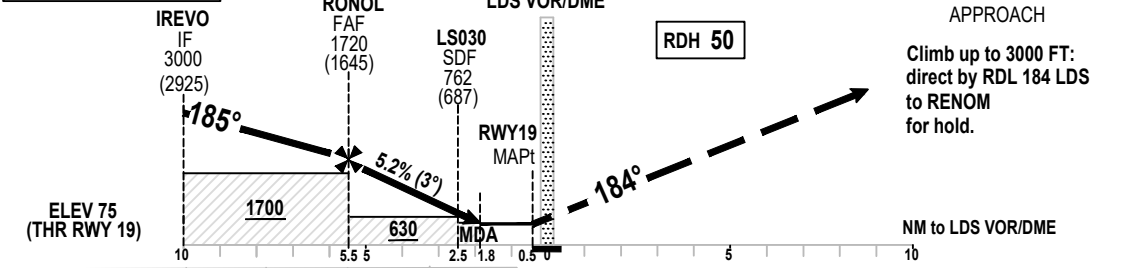

OCA/H		A	B	C	D	KT							
Straight-in Approach	VOR/DME	540(465)				80	100	120	140	160	180		
	VIS	1800 M - 2200 M ALS INOP				450	550	650	750	850	950		
NM to LDS VOR		5	4	3	2	1.8							
Altitude Height		1720	1399	1080	762	540							
		1645	1324	1005	687	465							

INSTRUMENT
APPROACH
CHART - ICAO

AERODROME ELEV **95 FT**
HEIGHTS RELATED TO
THR RWY 19 - ELEV 75 FT

TWR 118.3 - 122.1
ATIS 117.6

MALDONADO/Int'l
C/C Carlos A. Curbelo
Laguna del Sauce
VOR Z RWY 19

AERONAUTICAL DATA TABULATION

VOR Z approach to RWY 19 from DIDUX or EGANO	
Fix / Point	Coordinates
DIDUX (IAF)	34°47'33.41"S 055°16'40.20"W
EGANO (IAF)	34°45'28.83"S 054°55'47.71"W
IREVO (IF)	34°41'33.79"S 055°07'02.87"W
RONOL (FAF)	34°46'02.41"S 055°06'21.16"W
LS030 (SDF)	34°49'01.24"S 055°05'53.35"W
LS031 (FTP) (MAPT)	34°51'00.46"S 055°05'34.79"W
RWY19	34°51'00.79"S 055°05'39.56"W
LDS VOR/DME	34°51'29.9"S 055°05'30.2"W
RENOM (MAHF)	35°01'25.02"S 055°03'48.53"W

Change:
New chart

INSTRUMENT
APPROACH
CHART - ICAO

AERODROME ELEV **95 FT**
HEIGHTS RELATED TO
THR RWY 26 - ELEV 72 FT

TWR 118.3 - 122.1
ATIS 117.6

MALDONADO/Int'l
C/C Carlos A. Curbelo
Laguna del Sauce
VOR Z RWY 26

AERONAUTICAL DATA TABULATION

VOR Z approach to RWY 26 from MEXIM or OBLAS	
Fix / Point	Coordinates
MEXIM (IAF)	34°41'29.12"S 055°05'41.38"W
OBLAS (IAF)	34°56'21.83"S 054°54'52.78"W
SIMAP (IF)	34°46'22.37"S 054°55'04.32"W
BURBU (FAF)	34°48'50.48"S 055°00'05.36"W
LS032 (SDF)	34°50'16.60"S 055°03'00.70"W
LS033 (FTP) (MAPT)	34°51'24.18"S 055°05'18.53"W
RWY26	34°51'14.69"S 055°05'23.69"W
LDS VOR/DME	34°51'29.9"S 055°05'30.2"W
RENOM (MAHF)	35°01'25.02"S 055°03'48.53"W

Change:
New chart

ATC SURVEILLANCE
MINIMUM ALTITUDE
CHART - ICAO

AERODROME ELEV 95 FT
TRANSITION ALT 3000 FT

SUMU APP
119.2 - 120.2

MALDONADO/Intl
C/C Carlos A. Curbelo
Laguna del Sauce

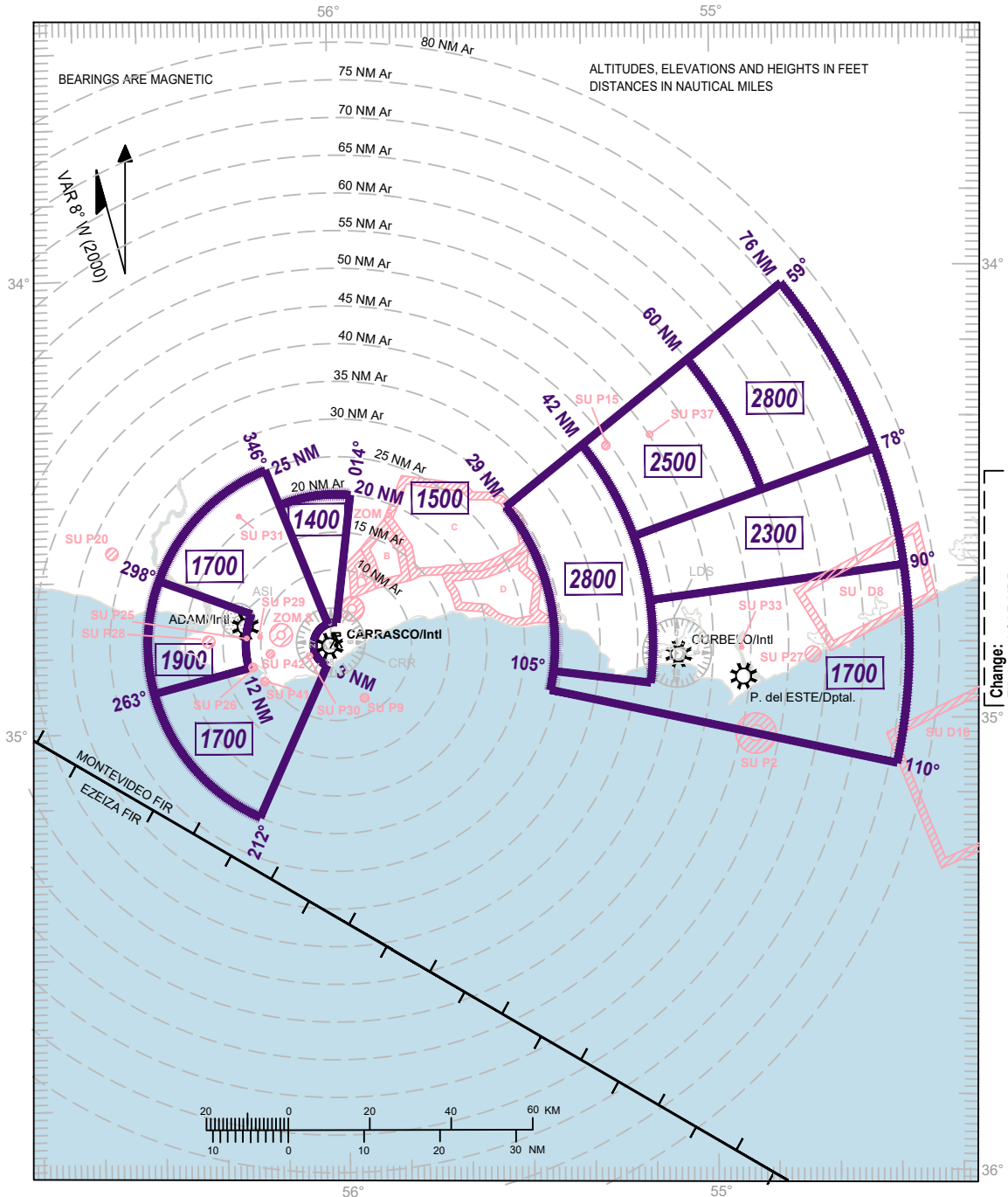

Ar = Distance to the Radar Antenna located at: 34°49'54.9"S/056°00'42.8"W

**INTENTIONALLY
LEFT BLANK**